

PRODUCT FEATURES

- Ultrafast Recovery Time
- Low Recovery Loss
- Soft Reverse Recovery Characteristics
- Low Leakage Current
- Low Forward Voltage
- High Surge Current Capability

APPLICATIONS

- Freewheeling, Snubber, Clamp
- Inversion Welder
- PFC
- Plating Power Supply
- Ultrasonic Cleaner and Welder
- Converter & Chopper
- UPS

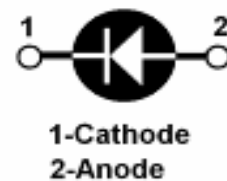
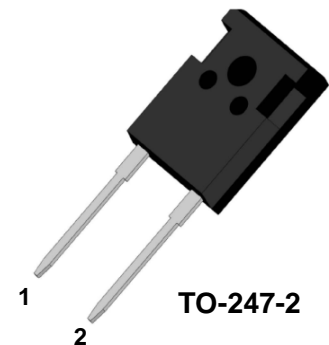

DESCRIPTION

FRED from MacMic utilizes advanced processing techniques to achieve ultrafast recovery times and higher forward current. Its soft recovery characteristics and high reliability suit for wide industrial applications.

ABSOLUTE MAXIMUM RATINGS ($T_C=25^{\circ}\text{C}$ unless otherwise specified)

Symbol	Parameter/Test Conditions		Values	Unit
V_R	Maximum D.C. Reverse Voltage		600	V
V_{RRM}	Maximum Repetitive Reverse Voltage			
$I_{F(AV)}$	Average Forward Current	$T_C=105^{\circ}\text{C}$	60	A
$I_{F(RMS)}$	RMS Forward Current	$T_C=105^{\circ}\text{C}$	84	
I_{FSM}	Non Repetitive Surge Forward Current	$T_J=25^{\circ}\text{C}, t=10\text{ms}, 50\text{Hz}, \text{Sine}$	580	
P_D	Power Dissipation		300	W
T_J	Junction Temperature		-55 to +175	$^{\circ}\text{C}$
T_{STG}	Storage Temperature Range		-55 to +150	$^{\circ}\text{C}$
Torque	To Heat Sink	Recommended (M3)	1.1	Nm
R_{thJC}	Junction to Case Thermal Resistance		0.5	$^{\circ}\text{C}/\text{W}$
Weight			6	g

ELECTRICAL CHARACTERISTICS ($T_C=25^{\circ}\text{C}$ unless otherwise specified)

Symbol	Parameter/Test Conditions		Min.	Typ.	Max.	Unit
I_{RM}	Maximum Reverse Leakage Current	$V_R = 600\text{V}$			10	μA
		$V_R = 600\text{V}, T_J = 150^{\circ}\text{C}$			1	mA
V_F	Forward Voltage	$I_F=60\text{A}$		2	2.6	V
		$I_F=60\text{A}, T_J=150^{\circ}\text{C}$		1.6		
t_{rr}	Reverse Recovery Time ($I_F = 1\text{A}, di_F/dt = -200\text{A}/\mu\text{s}, V_R = 30\text{V}$)			25	35	ns
t_{rr}	Reverse Recovery Time ($I_F = 0.5\text{A}, I_R=1\text{A}, I_{RR} = 0.25\text{A}$)			45	60	ns

MacMic Science & Technology Co., Ltd.

Add: #18, Hua Shan Zhong Lu, New District, Changzhou City, Jiangsu Province, P. R. of China

ELECTRICAL CHARACTERISTICS ($T_C=25^{\circ}\text{C}$ unless otherwise specified)

Symbol	Parameter/Test Conditions	Min.	Typ.	Max.	Unit
t_{rr}	Reverse Recovery Time		45		ns
I_{RRM}	Maximum Reverse Recovery Current		4.5		A
Q_{RR}	Reverse Recovery Charge		250		nC
t_{rr}	Reverse Recovery Time		110		ns
I_{RRM}	Maximum Reverse Recovery Current		12		A
Q_{RR}	Reverse Recovery Charge		500		nC

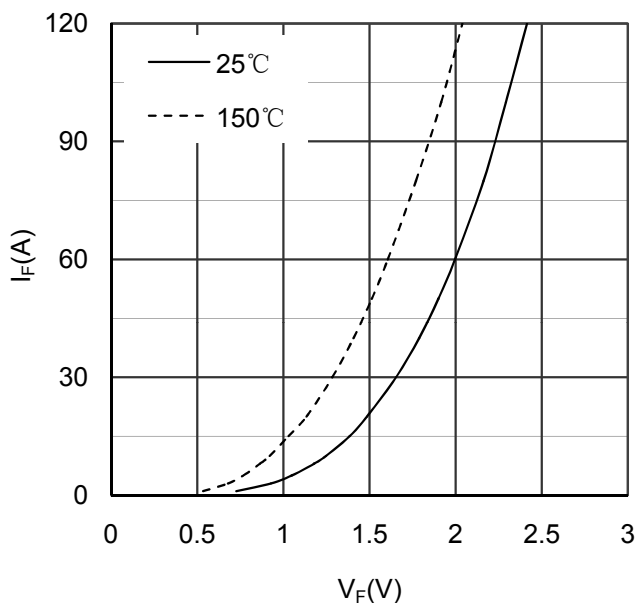

Figure 1. Forward Voltage Drop vs Forward Current

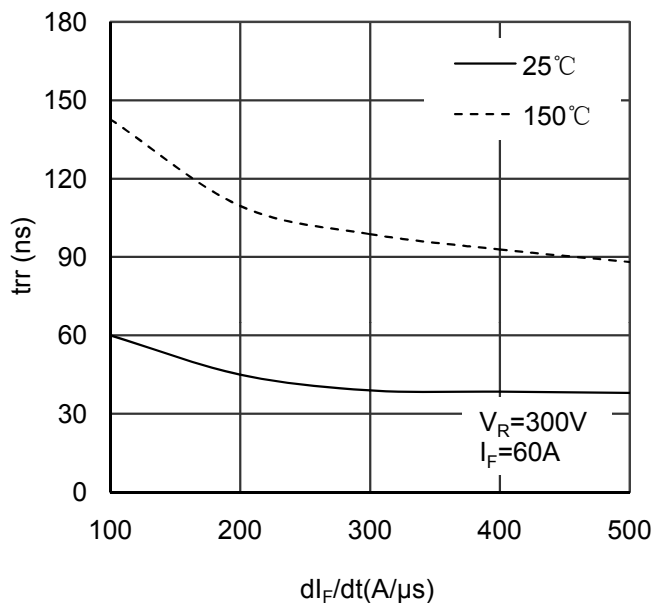

Figure 2. Reverse Recovery Time vs di_F/dt

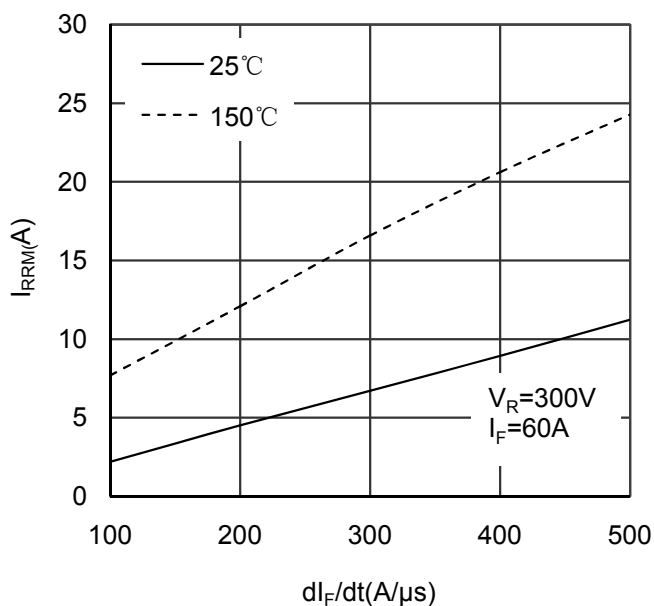

Figure 3. Reverse Recovery Current vs di_F/dt

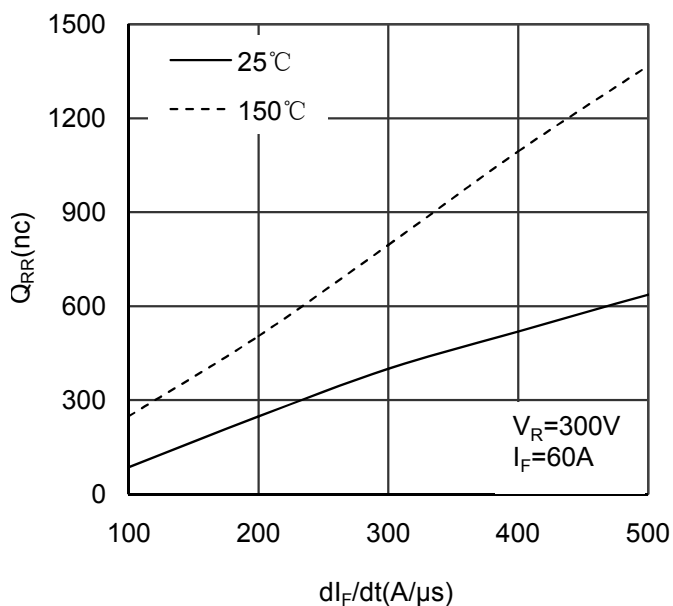

Figure 4. Reverse Recovery Charge vs di_F/dt

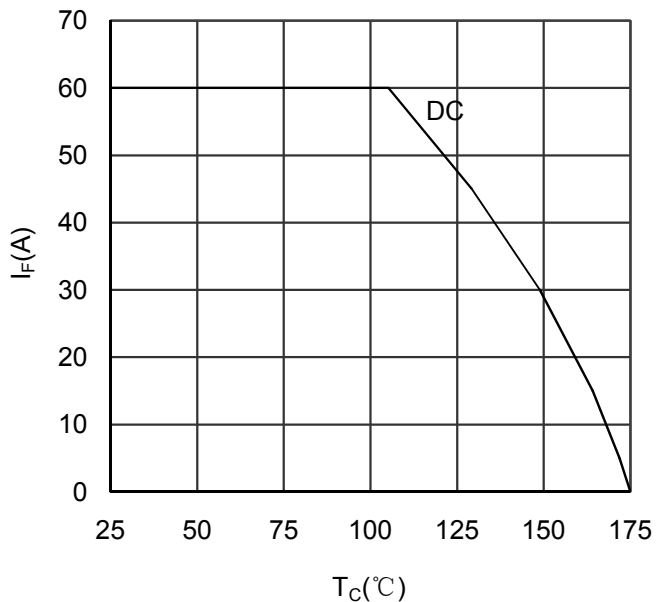

Figure 5. Forward current vs Case temperature

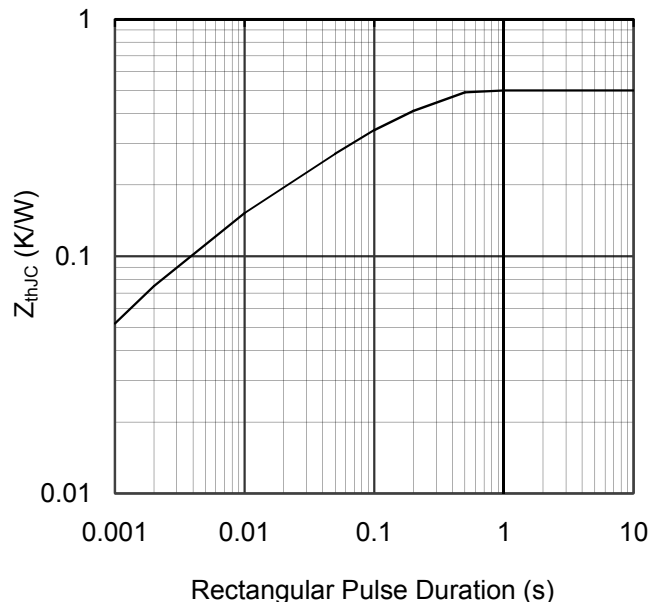

Figure 6. Transient Thermal Impedance

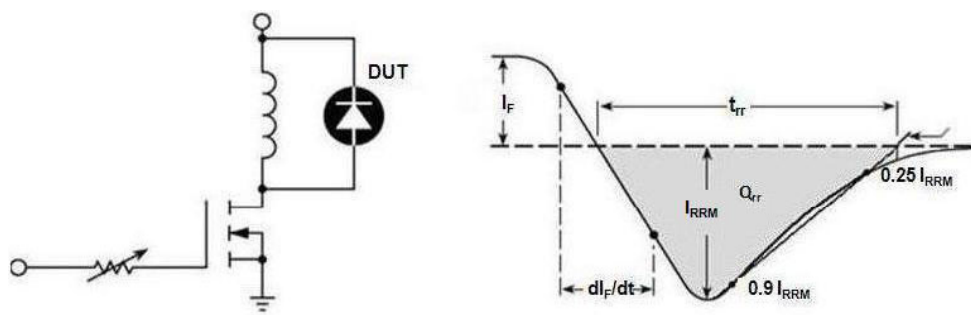
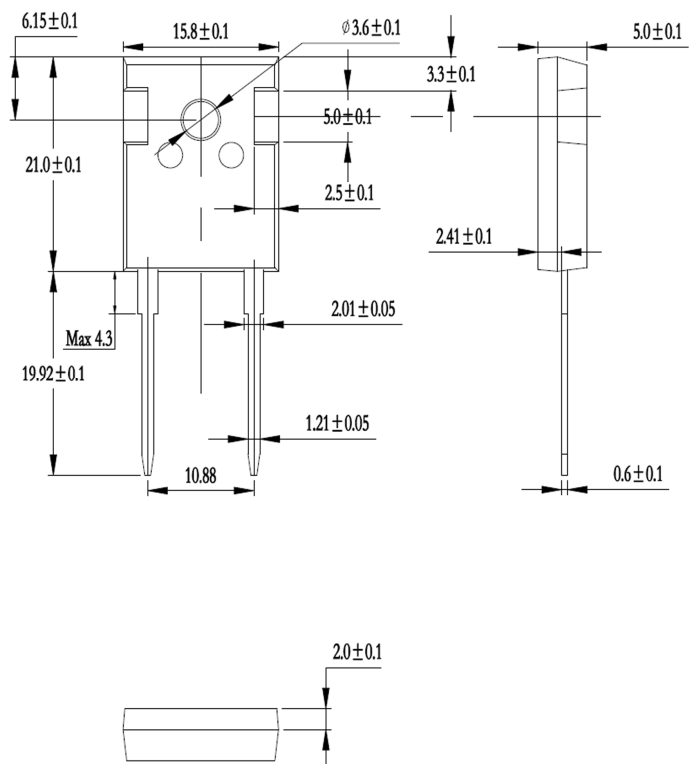

Figure 7. Diode Reverse Recovery Test Circuit and Waveform



Dimensions in (mm)

Figure 8. Package Outline